

500mA, Low Voltage, LDO Regulator with External Bias Supply

General Description

The RT9041E is a low voltage, low dropout linear regulator with an external bias supply input. The bias supply drives the gate of the internal N-MOSFET pass transistor, making these devices ideal for applications that require low voltage outputs from low voltage inputs. The RT9041E provides fixed output voltage from 1V to 2V with 0.1V increments. Adjustable output voltage is available for the RT9041E by using external resistors. Other features include current limit and thermal shutdown to protect regulator from fault conditions.

The RT9041E is available in a WDFN-8L 2x2 package.

Ordering Information

RT9041E-	□	□	□
	Package Type		
	QW : WDFN-8L 2x2		
	Lead Plating System		
	G : Green (Halogen Free and Pb Free)		
	Output Voltage		
	10 : 1.0V/Adj		
	11 : 1.1V/Adj		
	:		
	19 : 1.9V/Adj		
	20 : 2.0V/Adj		

Note :

Richtek products are :

- ▶ RoHS compliant and compatible with the current requirements of IPC/JEDEC J-STD-020.
- ▶ Suitable for use in SnPb or Pb-free soldering processes.

Marking Information

For marking information, contact our sales representative directly or through a Richtek distributor located in your area.

Features

- $\pm 2\%$ Output Voltage Accuracy
- No Minimum Load Current Required
- 1V to 5.5V Input Supply Voltage
- 3V to 5.5V Input Bias Supply Voltage
- PGOOD Open-Drain Output
- Supports Fixed/Adjustable Output Voltage
- Low Supply Current
- 5 μ A (max) Shutdown Supply Current
- RoHS Compliant and Halogen Free

Applications

- Set Top Box
- Notebook Computers
- VID Power Supplies
- PDAs
- Cell Phones
- Low Dropout Regulators with External Bias Supply

Pin Configurations

(TOP VIEW)

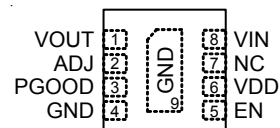

WDFN-8L 2x2

Typical Application Circuit

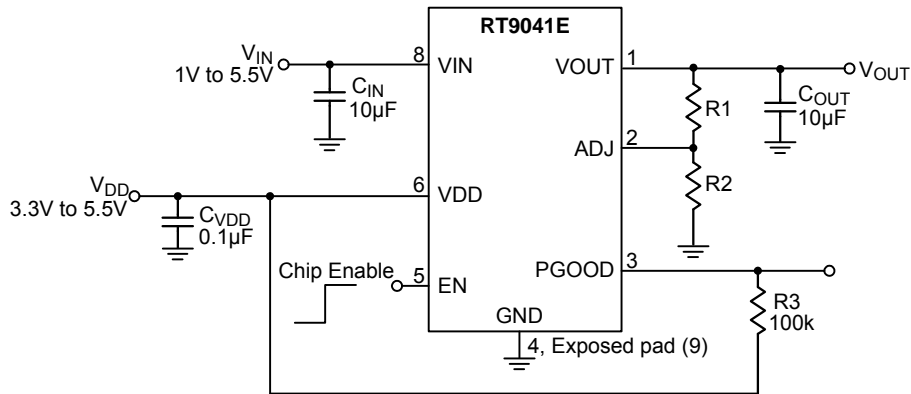

Function Pin Description

Pin No.	Pin Name	Pin Function
1	VOUT	Output Voltage.
2	ADJ	Output Voltage Adjust Pin. Set the output voltage by the internal feedback resistors when ADJ is ground. If external feedback resistors is used, $V_{OUT} = V_{REF} \times (R1 + R2)/R2$.
3	PGOOD	Power Good Open Drain Output.
4, 9 (Exposed pad)	GND	Ground. The exposed pad must be soldered to a large PCB and connected to GND for maximum power dissipation.
5	EN	Chip Enable (Active-High).
6	VDD	Supply Voltage of Control Circuitry.
7	NC	No Internal Connection.
8	VIN	Supply Input Voltage.

Function Block Diagram

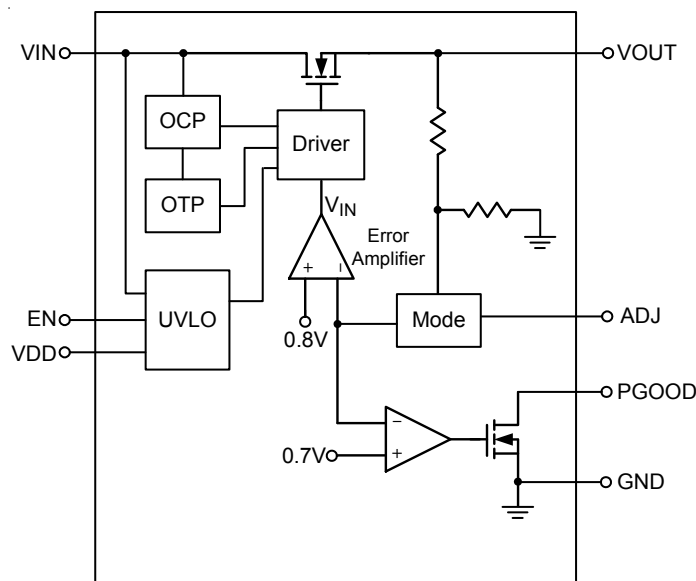

Absolute Maximum Ratings (Note 1)

- Bias Supply Input Voltage, VDD ----- 6V
- Supply Input Voltage, VIN ----- 6V
- Other Input/Output Pins ----- 6V
- Power Dissipation, P_D @ T_A = 25°C
 - WDFN-8L 2x2 ----- 0.833VW
- Package Thermal Resistance (Note 2)
 - WDFN-8L 2x2, θ_{JA} ----- 120°C/W
 - WDFN-8L 2x2, θ_{JC} ----- 8.2°C/W
- Lead Temperature (Soldering, 10 sec.) ----- 260°C
- Junction Temperature ----- 150°C
- Storage Temperature Range ----- -65°C to 150°C
- ESD Susceptibility (Note 3)
 - HBM (Human Body Model) ----- 2kV

Recommended Operating Conditions (Note 4)

- Bias Supply Input Voltage, VDD ----- 3V to 5.5V
- Supply Input Voltage, VIN ----- 1V to 5.5V
- Junction Temperature Range ----- -40°C to 125°C
- Ambient Temperature Range ----- -40°C to 85°C

Electrical Characteristics

(V_{IN} = 1.8V, I_{LOAD} = 1mA, C_{OUT} = 10μF, T_A = 25°C unless otherwise specified)

Parameter	Symbol	Test Conditions	Min	Typ	Max	Unit
Input						
Adjustable Output Voltage Range	V _{OUT}		0.8	--	2.5	V
Bias Input Under Voltage Lockout	V _{UVLO}		--	2.7	--	V
VIN Shutdown Current	I _{SHDN}	1V < V _{IN} < 5.5V, V _{IN} = V _{OUT} + 0.6V	--	1	5	μA
Quiescent Current	I _Q	3V < V _{DD} < 5.5V	--	160	250	μA
VDD Shutdown Current	I _{SHDN}	3V < V _{DD} < 5.5V	--	1	5	μA
Regulator Characteristics						
Line Regulation	ΔV _{OUT} / ΔV _{IN}	I _{OUT} = 10mA, 1.5V < V _{IN} < 5.5V, V _{IN} = V _{OUT} + 0.6V	-0.15	--	0.15	%/V
Load Regulation	ΔV _{OUT} / ΔI _{IN}	V _{IN} = V _{OUT} + 0.6V, I _{LOAD} = 1mA to 300mA	--	0.2	1	%
Fixed Output Voltage Accuracy	ΔV _{OUT}	Short ADJ to GND, I _{OUT} = 10mA	-2	--	2	%
Reference Voltage	V _{REF}	I _{OUT} = 10mA	0.784	0.8	0.816	V
Dropout Voltage	V _{DROP}	I _{OUT} = 300mA, V _{DD} - V _{OUT} ≥ 2.1V	--	200	300	mV
		I _{OUT} = 500mA, V _{DD} - V _{OUT} ≥ 2.1V	--	300	500	
Current Limit	I _{LIM}	R _{LOAD} = 0	550	700	1400	mA
Thermal-Shutdown	T _{SD}	3V < V _{DD} < 5.5V	--	160	--	°C
Thermal-Shutdown Hysteresis	ΔT _{SD}		--	20	--	°C

Parameter	Symbol	Test Conditions	Min	Typ	Max	Unit
ADJ						
ADJ Pin Threshold			--	0.2	--	V
PGOOD Comparator						
Comparator Threshold		% of regulated output voltage	--	88	--	%
Comparator Hysteresis	V _{HYST}	(Note 5)	--	10	--	mV
Logic and I/O						
EN Input Voltage	Logic-High	V _{IH}	1.6	--	--	V
	Logic-Low	V _{IL}	--	--	0.8	
EN Current	I _{EN}	V _{EN} = 5V	--	12	--	μA
PGOOD Output Low Voltage		PGOOD sinking 1mA	--	--	0.1	V
PGOOD Output High Leakage Current		0 < V _{PGOOD} < V _{IN}	-1	--	1	μA
Dynamics						
PGOOD Propagation Delay	t _{PGOOD}	Rising edge within 5% of regulation level	1	--	5	ms

Note 1. Stresses beyond those listed “Absolute Maximum Ratings” may cause permanent damage to the device. These are stress ratings only, and functional operation of the device at these or any other conditions beyond those indicated in the operational sections of the specifications is not implied. Exposure to absolute maximum rating conditions may affect device reliability.

Note 2. θ_{JA} is measured at $T_A = 25^\circ\text{C}$ on a high effective thermal conductivity four-layer test board per JEDEC 51-7. θ_{JC} is measured at the exposed pad of the package.

Note 3. Devices are ESD sensitive. Handling precaution is recommended.

Note 4. The device is not guaranteed to function outside its operating conditions.

Note 5. Guaranteed by Design.

Typical Operating Characteristics

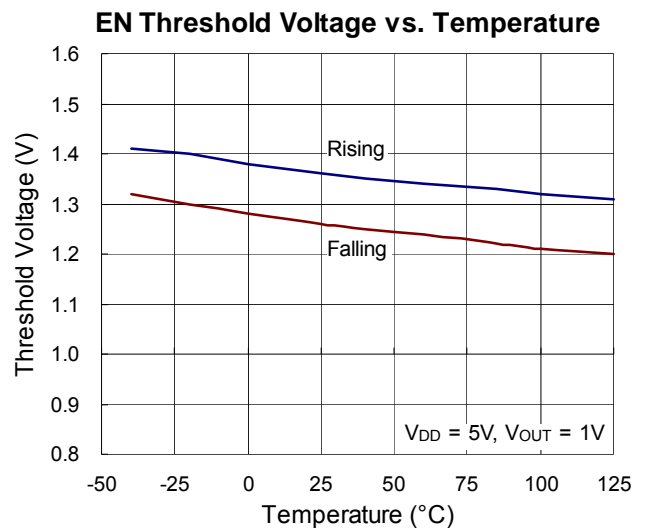
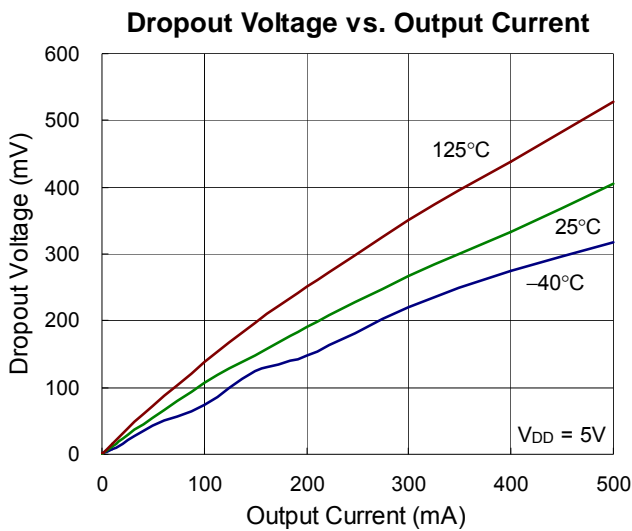
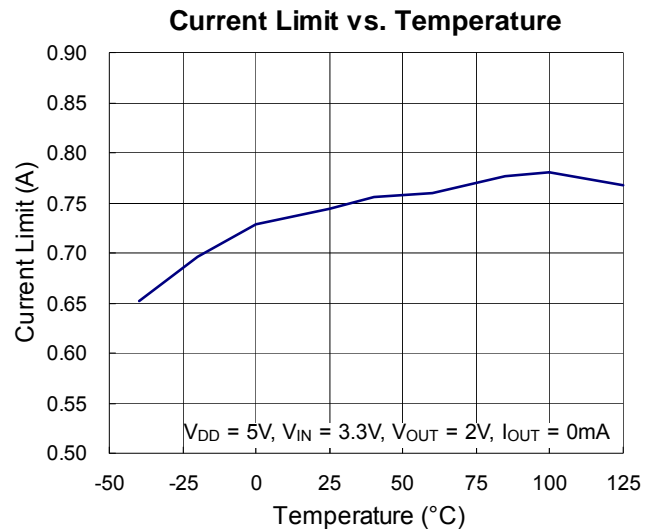
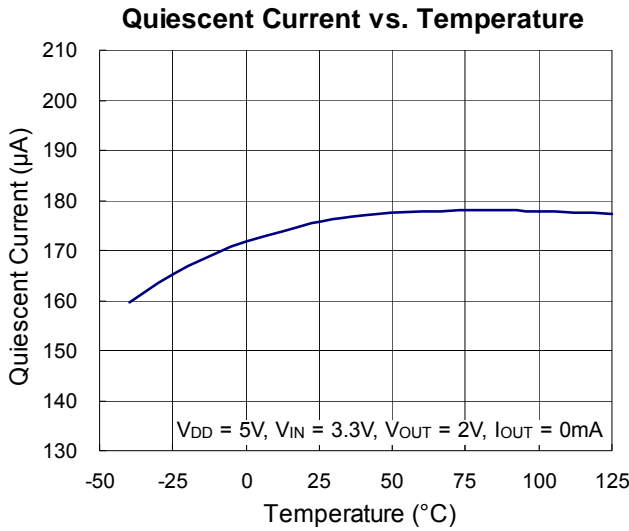
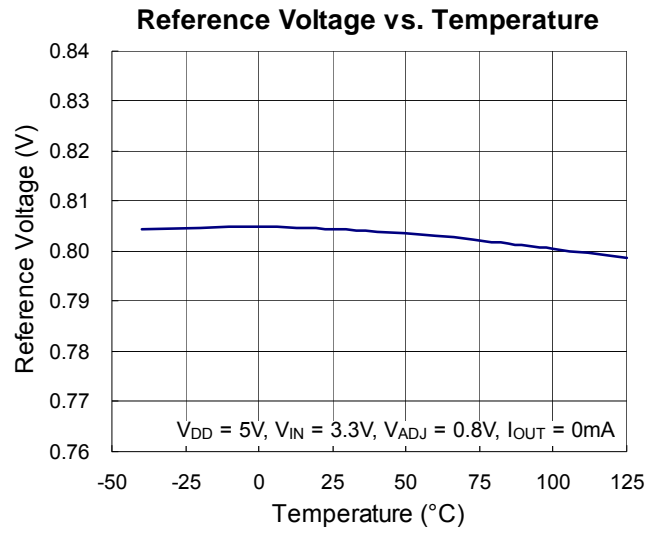
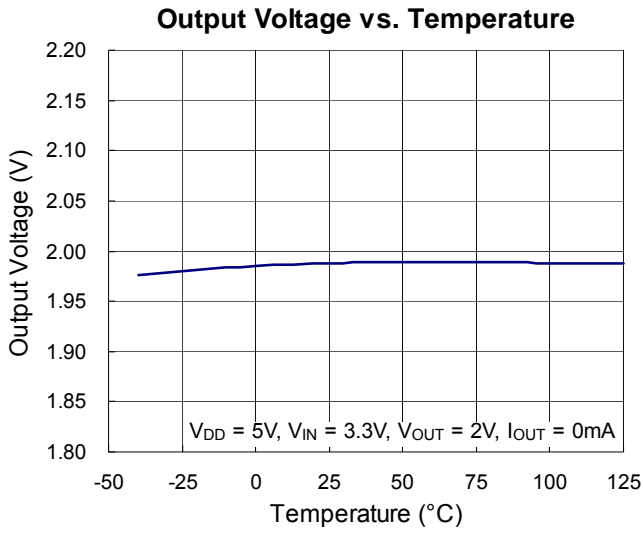

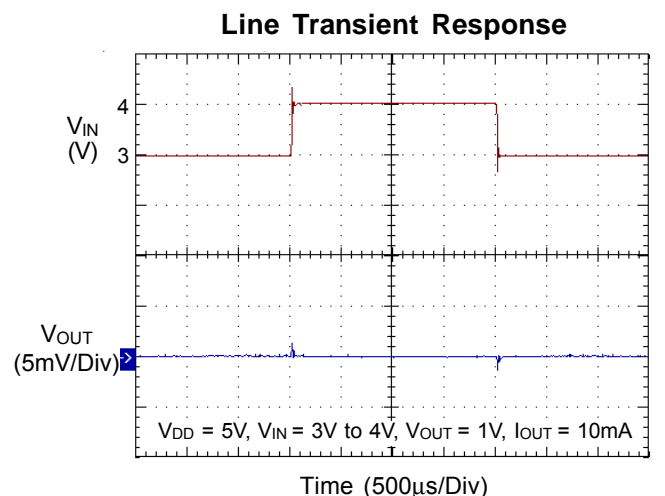
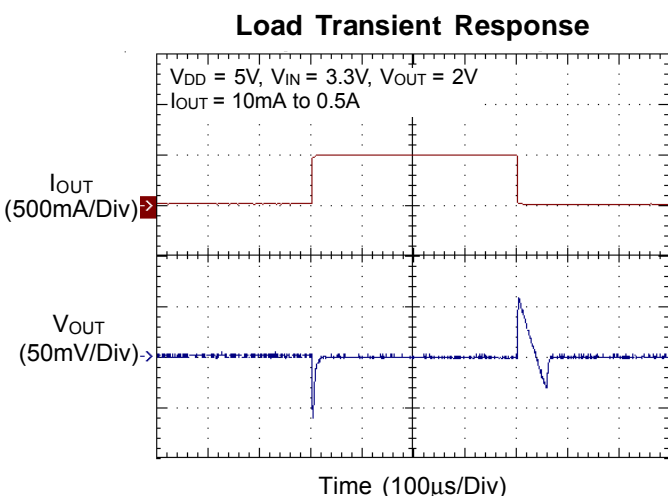
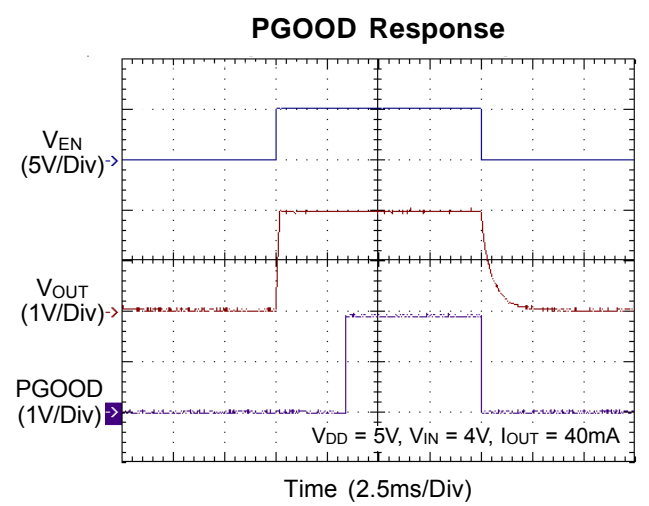
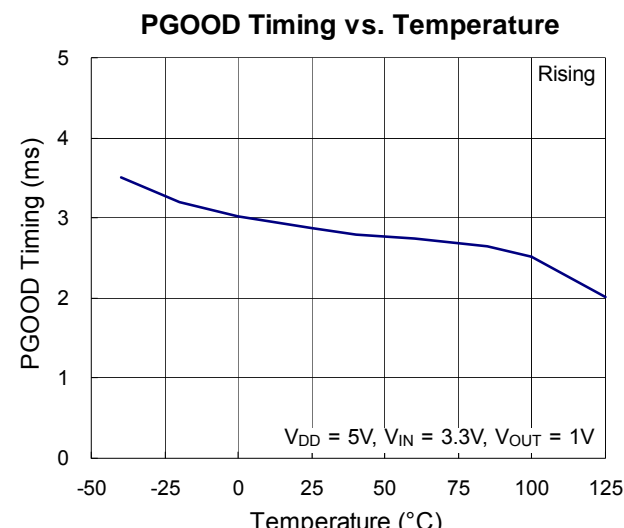
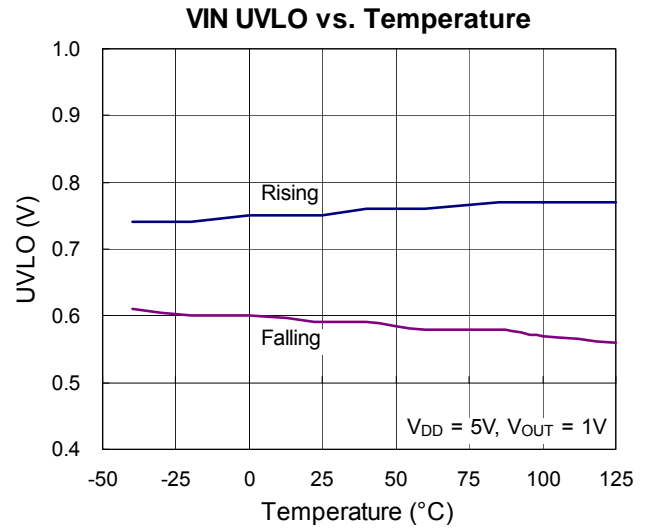
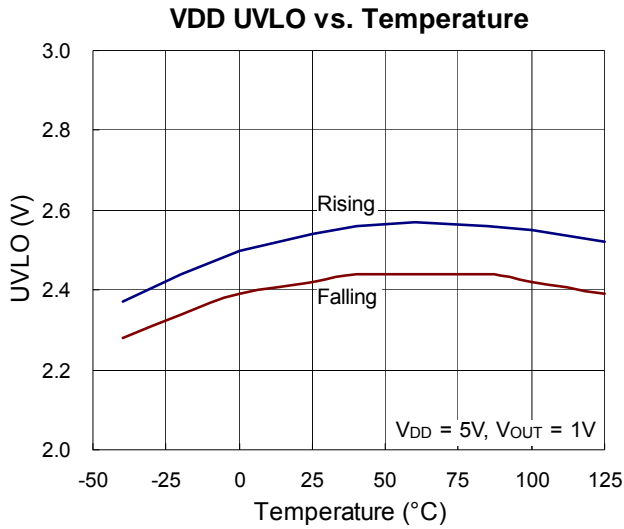

Line Transient Response

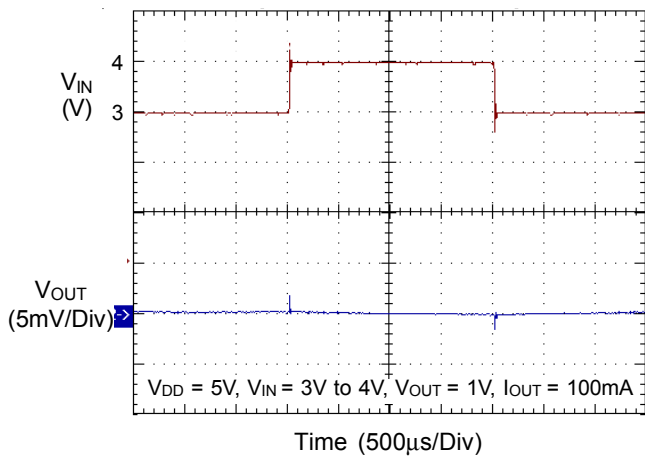

EN Response

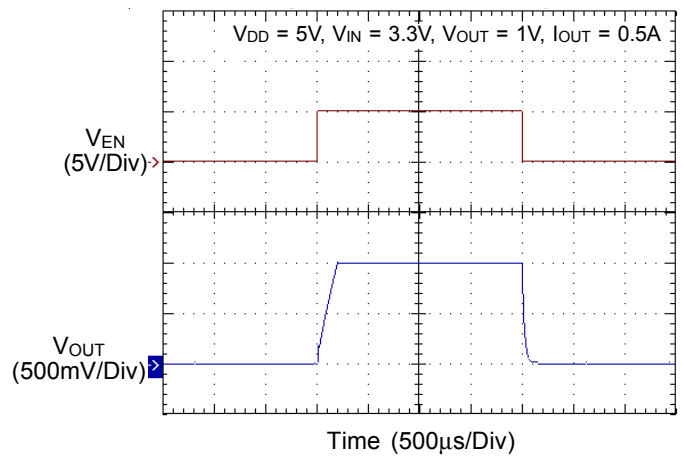

PSRR

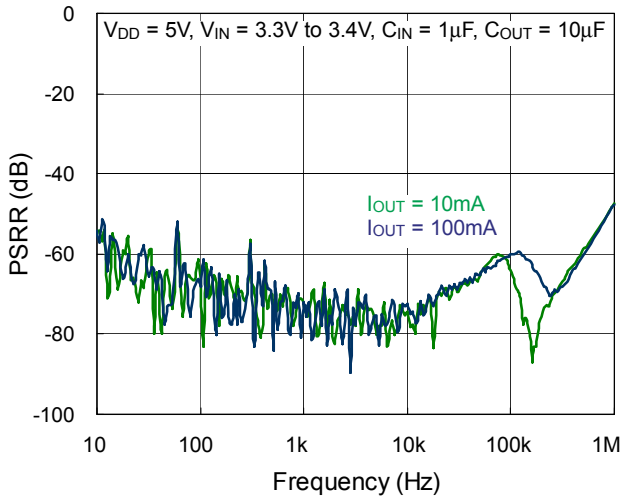

Noise

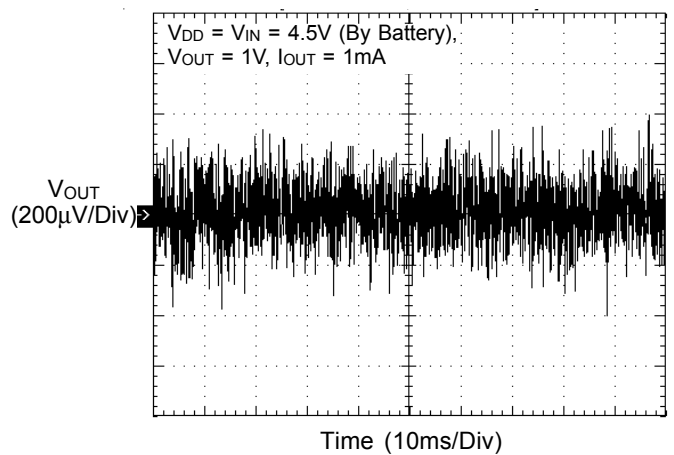

Noise

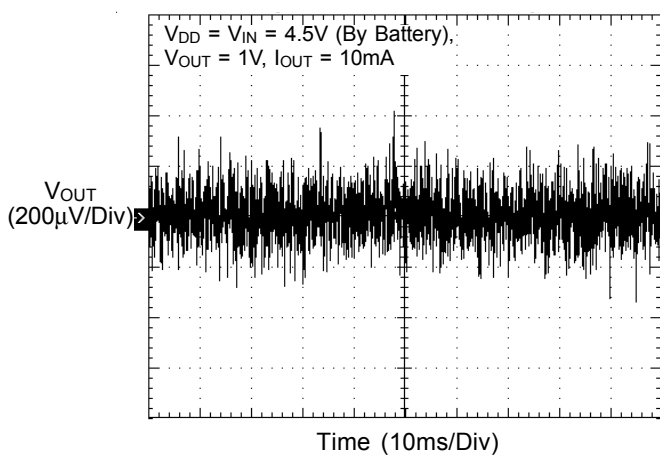

Application Information

The RT9041E is a low voltage, low dropout linear regulator with an external bias supply input, capable of supporting an input voltage range from 1V to 5.5V with a fixed output voltage from 1V to 2V in 0.1V increments.

Supply Voltage Setting

The bias supply voltage (V_{DD}) operates from 3V to 5.5V. For better efficiency, it is suggested to operate V_{DD} at 5V when the output voltage is higher than 1V. Figure 1 shows the curves of the recommended $V_{DD} - V_{OUT}$ range vs. the dropout voltage ($V_{IN} - V_{OUT}$) values.

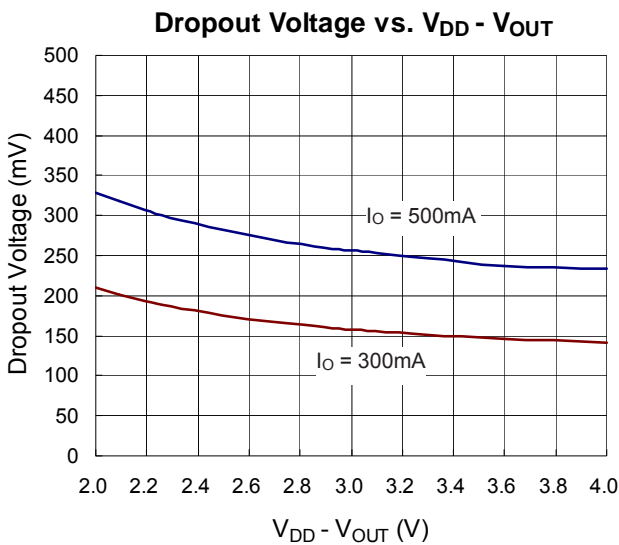

Figure 1. Dropout Voltage vs. $V_{DD} - V_{OUT}$

Output Voltage Setting

The RT9041E output voltage is also adjustable from 0.8V to 2.5V via the external resistive voltage divider. The voltage divider resistors can have values up to 800k Ω because of the very high impedance and low bias current of the sense comparator. The output voltage is set according to the following equation :

$$V_{OUT} = V_{REF} \times \left(1 + \frac{R1}{R2} \right)$$

where V_{REF} is the reference voltage with a typical value of 0.8V.

Chip Enable Operation

The RT9041E goes into sleep mode when the EN pin is in a logic low condition. In this condition, the pass transistor, error amplifier, and band gap are all turned off, reducing the supply current to 1 μ A (typ.). The EN pin can be directly tied to V_{IN} to keep the part on.

Current Limit

The RT9041E contains an independent current limit circuitry, which monitors and controls the pass transistor's gate voltage, limiting the output current to 0.7A (typ.).

CIN and COUT Selection

Like any low dropout regulator, the external capacitors of the RT9041E must be carefully selected for regulator stability and performance. Using a capacitor of at least 10 μ F is suitable. The input capacitor must be located at a distance of not more than 0.5 inch from the input pin of the IC. Any good quality ceramic capacitor can be used. However, a capacitor with larger value and lower ESR (Equivalent Series Resistance) is recommended since it will provide better PSRR and line transient response.

The RT9041E is designed specifically to work with low ESR ceramic output capacitor for space saving and performance consideration. Using a ceramic capacitor with value at least 10 μ F and ESR larger than 40m Ω on the RT9041E output ensures stability. Nevertheless, the RT9041E can still work well with other types of output capacitors due to its wide range of stable ESR. Figure 2 shows the allowable ESR range as a function of load current for various output capacitance. Output capacitors with larger capacitance can reduce noise and improve load transient response, stability, and PSRR. The output capacitor should be located at a distance of not more than 0.5 inch from the output pin of the RT9041E.

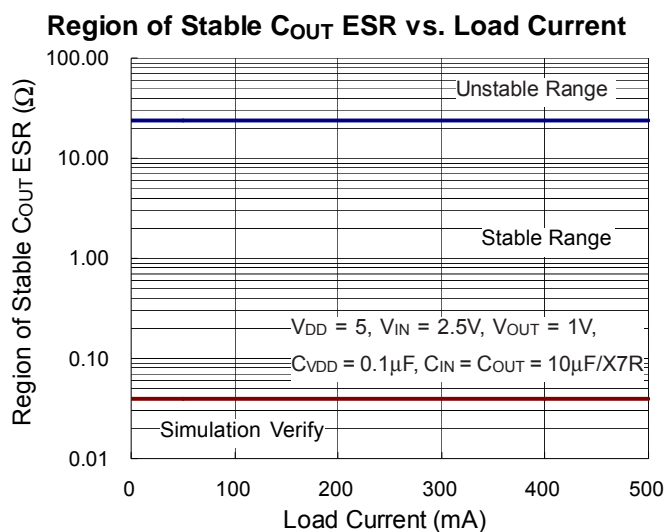

Figure 2. Region of Stable C_{OUT} ESR vs. the Load Current

Thermal Considerations

For continuous operation, do not exceed absolute maximum junction temperature. The maximum power dissipation depends on the thermal resistance of the IC package, PCB layout, rate of surrounding airflow, and difference between junction and ambient temperature. The maximum power dissipation can be calculated by the following formula :

$$P_{D(MAX)} = (T_{J(MAX)} - T_A) / \theta_{JA}$$

where T_{J(MAX)} is the maximum junction temperature, T_A is the ambient temperature, and θ_{JA} is the junction to ambient thermal resistance.

For recommended operating condition specifications, the maximum junction temperature is 125°C. The junction to ambient thermal resistance, θ_{JA} , is layout dependent. For WDFN-8L 2x2 packages, the thermal resistance, θ_{JA} , is 120°C/W on a standard JEDEC 51-7 four-layer thermal test board. The maximum power dissipation at T_A = 25°C can be calculated by the following formula :

$$P_{D(MAX)} = (125^\circ\text{C} - 25^\circ\text{C}) / (120^\circ\text{C/W}) = 0.833\text{W for}$$

WDFN-8L 2x2 package

The maximum power dissipation depends on the operating ambient temperature for fixed T_{J(MAX)} and thermal resistance, θ_{JA} . The derating curve in Figure 3 allows the designer to see the effect of rising ambient temperature on the maximum power dissipation.

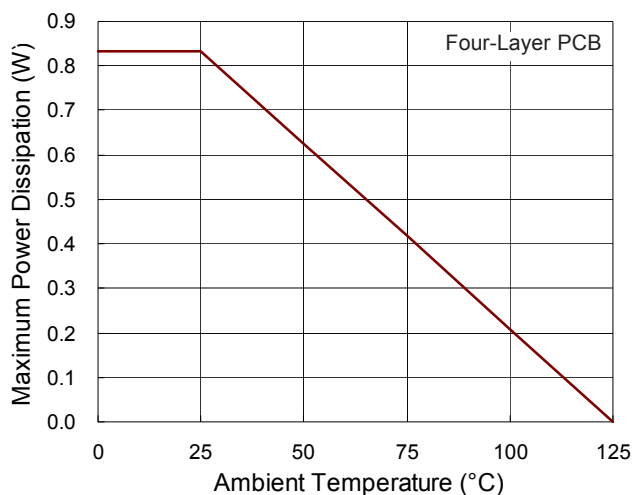
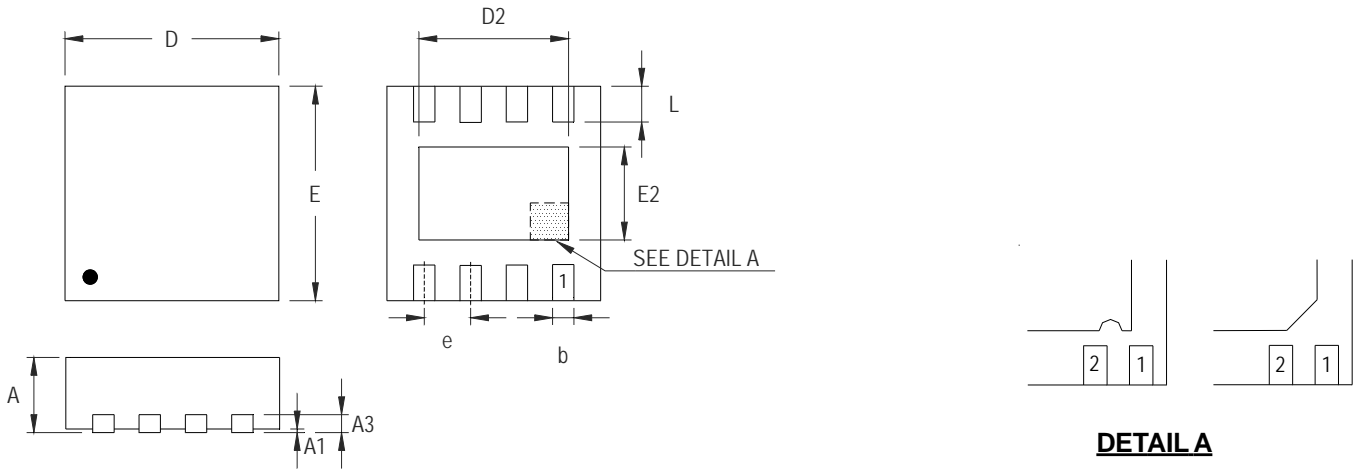

Figure 3. Derating Curve of Maximum Power Dissipation

Outline Dimension



DETAIL A

Pin #1 ID and Tie Bar Mark Options

Note : The configuration of the Pin #1 identifier is optional, but must be located within the zone indicated.

Symbol	Dimensions In Millimeters		Dimensions In Inches	
	Min	Max	Min	Max
A	0.700	0.800	0.028	0.031
A1	0.000	0.050	0.000	0.002
A3	0.175	0.250	0.007	0.010
b	0.200	0.300	0.008	0.012
D	1.950	2.050	0.077	0.081
D2	1.000	1.250	0.039	0.049
E	1.950	2.050	0.077	0.081
E2	0.400	0.650	0.016	0.026
e	0.500		0.020	
L	0.300	0.400	0.012	0.016

W-Type 8L DFN 2x2 Package

Richtek Technology Corporation

14F, No. 8, Tai Yuen 1st Street, Chupei City
 Hsinchu, Taiwan, R.O.C.
 Tel: (8863)5526789

Richtek products are sold by description only. Richtek reserves the right to change the circuitry and/or specifications without notice at any time. Customers should obtain the latest relevant information and data sheets before placing orders and should verify that such information is current and complete. Richtek cannot assume responsibility for use of any circuitry other than circuitry entirely embodied in a Richtek product. Information furnished by Richtek is believed to be accurate and reliable. However, no responsibility is assumed by Richtek or its subsidiaries for its use; nor for any infringements of patents or other rights of third parties which may result from its use. No license is granted by implication or otherwise under any patent or patent rights of Richtek or its subsidiaries.