

SOCKETS FOR TO-3 CASE

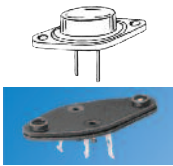

VARIOUS MOLDED BOSS HEIGHTS

MATERIAL:
Base: Phenolic, Grade PBE, Type XP
Contacts: Brass, Tin Plate
Top Plate: Nylon, ASTM-D4066
 Phenolic, Grade PBE, Type XP
 (Cat. No. 4606 only)
Collector Plate: Steel, Tin Plate

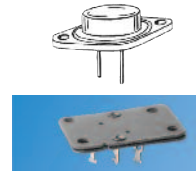

Socket and transistor are assembled to chassis at same time, using the minimum amount of hardware. Top molded boss ensure the transistor leads will be isolated from the chassis. Various boss heights available to accommodate different chassis thicknesses.

Socket is installed onto chassis using eyelets or screws. Transistor is installed afterwards. Assembly and repairs are simplified since socket will stay in place without transistor mounted. Top molded boss or added bushing ensure the transistor leads will be isolated from the chassis. Various boss heights available to accommodate standard chassis thicknesses. Use Cat. No. 4606 and nylon bushings for special chassis thicknesses.

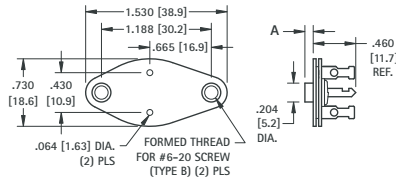

CAT. NO.	A DIM.
4603	.030 (.76)
4602	.045 (1.14)
4601	.090 (2.29)

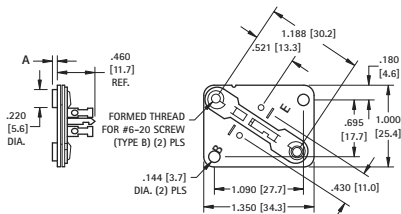

CAT. NO.	A DIM.
4606	NONE
4607	.030 (.76)
4608	.045 (1.14)
4609	.060 (1.52)
4618	.125 (3.2)

FULLY MOLDED TO-3 SOCKET



Pre-assembling the socket to the chassis by eyelets or rivets permits the installation of the semiconductor at a later stage in the assembly. The molded top boss eliminates hardware.

MATERIAL:
Base: Molded Nylon 6/6
Contacts: Brass, Tin Plate
Collector Plate: Steel, Tin Plate

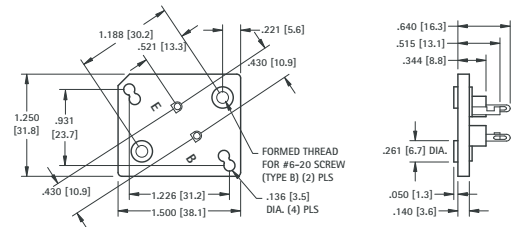

CAT. NO. 4620

HEAVY DUTY SOCKET FOR TO-3 CASE

CHOICE OF SINGLE OR DUAL COLLECTOR SOLDER TABS

Features an all-in-one mounting plate and solder tabs, providing complete electrical isolation of the solder tab connections. Rated 5 Amps DC continuous and 15 Amps DC Intermittent

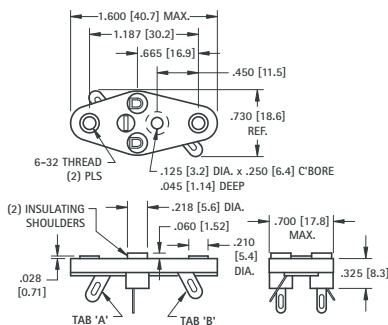

MATERIAL:
Base: PBT, UL Rated 94V-0
Contacts: Brass, Tin Plate
Collector Plate: Brass, Tin Plate

With transistor lead-in insulating shoulders

CAT. NO.	WITH TAB
4513	"A" ONLY
4514	"A" & "B"

Less transistor lead-in insulating shoulders

CAT. NO.	WITH TAB
4515	"A" ONLY
4516	"A" & "B"

TO-3 CASE MOUNTING KITS

These socket kits provide everything needed to mount a transistor onto a chassis in one kit. Nylon bushings or boss will insulate transistor leads from chassis. Mica insulator isolates transistor from chassis. Two 6-20 screws included to mount transistor. (Transistor not included)

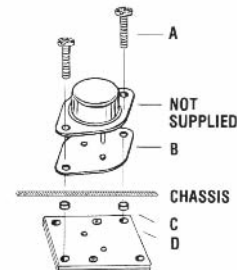
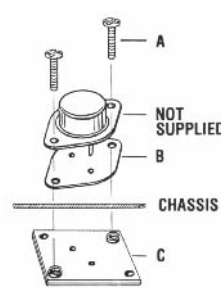
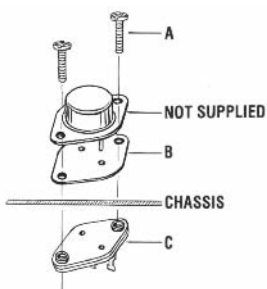

CAT. NO. 4732 Complete Mounting Kit			
ITEM	CAT. NO.	DESCRIPTION	QUANTITY
A	4706	6-20 screws	2
B	4651	Mica Insulator	1
C	4602	Socket	1

CAT. NO. 4733 Complete Mounting Kit			
ITEM	CAT. NO.	DESCRIPTION	QUANTITY
A	4706	6-20 screws	2
B	4651	Mica Insulator	1
C	4608	Square Socket	1

CAT. NO. 4734 Complete Mounting Kit			
ITEM	CAT. NO.	DESCRIPTION	QUANTITY
A	4706	6-20 screws	2
B	4651	Mica Insulator	1
C	4684	Nylon Bushing	4
D	4606	Square Socket	1